



Submersible Sewage Pumps

Vortex Impeller

U/UZ



Featuring a vortex impeller recessed in the widely opened pump casing interior, the U and UZ pumps can handle sewage with large solids without clogging or winding.

Cable Entry

Every cable has an anti-wicking block at the cable entry section of the pump. This mechanism is such that a part of each conductor is stripped back and the part is sealed by molded rubber or epoxy potting which has flowed in between each strand of the conductor.



This unique feature prevents wicking under the strands of the conductor itself.

Mechanical Seal

All pumps are provided with a Silicon Carbide dual inside mechanical seal that is located completely out of the pumpage, running in an oil-filled chamber. The advantages of this seal are two-fold, it eliminates spring failure caused by corrosion, abrasion or fouling which prevents the seal faces from closing properly, and prevents loss of cooling to the bottom seal faces during run-dry conditions which causes the bottom seal to fail.



Oil Lifter (Pat. Pending)

Utilizing the rotational energy of the shaft seal, the Oil Lifter forcibly supply lubricating oil to the mechanical seal. It continues to supply the lubricant to the top seal faces even if lubricant falls below the rated volume. This amazingly simple device not only turns wasted energy into added protection but also doubles the life expectancy of the mechanical seal and also the maintenance term.

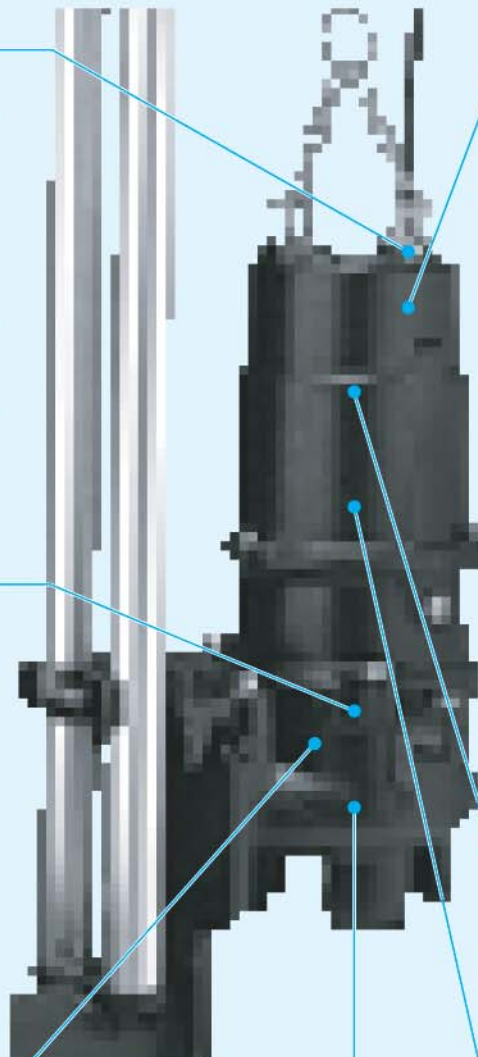
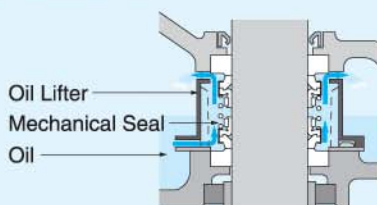

Motor Protector

Each pump up to 7.5kW as standard has a built in auto-cut, self-resetting Circle Thermal Protector (CTP).

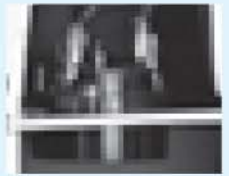

Integrated in the motor housing, the CTP directly cuts the motor circuit if excessive heat builds up or an overcurrent caused by an electrical or mechanical failure occurs.

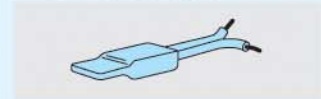

Miniature Thermal Protectors (MTPs) are imbedded in the winding of the pumps of star delta starting. These MTPs are connected in series, and their wires are led out of the motor. Should the winding temperature rise to the actuating temperature, the bimetal strip opens to cause the control panel to shut the power supply.

Motor

The motor is dry type, squirrel cage induction motor, housed in a cast iron, watertight casing, and conforms to insulation class of E or F. In each of these insulation classes, all standard pumps can be used in the maximum ambient temperature of 40°C.

Shaft

The high tensile stainless steel used on all pumps is designed to have an adequate strength for the transmission of the full load. The shaft is supported by C3 type, high quality, deep groove ball bearings.

Impeller

The vortex impeller is recessed in the upper part of the pump casing. Sewage is pumped out by the whirlpool action induced by the impeller. Being coupled with a wide pump casing, large solids and fibrous matters can be pumped out without obstruction.



COMPOSITION OF THE MODEL NAME

100 UZ A 4 3.7 S

Discharge Bore in millimeters

Name of the Series

Sub Code for the type

None : none-auto type
A : Automatic type
W : Auto-alternation

Phase

None : Three-phase
S : Single-phase

Rated motor output in Kilowatts

Number of poles of the Motor

(This model does not exist.)

GUIDE RAIL FITTINGS

We recommend using the Tsurumi guide rail fitting system with pumps. This system connects the pump to and from the piping easily just by lowering and hoisting the pump, allowing easy maintenance and inspection without the need to enter the sump.

TOS

The TOS guide rail fitting system is made of cast iron and is compatible with Tsurumi cast-iron pumps. Refer to the specification table for the correct model number prefixed with TOS.



TS

This compact guide rail fitting system is ideal for installing on prefabricated lift stations. Its discharge flange is compatible with major flange standards including ANSI 150lb, BS PN10, and DIN PN10. Four models are available and can be used on Tsurumi cast-iron pumps in the 50 mm through 100 mm discharge bore range.



TOK

Made of high quality resin, the TOK is designed for light-weight, small pumps. Rubber bellows attached to the guide hook are inverted to the duckfoot bend when the pump starts operating. This eliminates leakage at the seal even if a light-weight pump is used in combination with the TOK.

The TOK can be used with the U series pumps of 0.25kw through 0.75kw with maximum discharge bore of 50mm.



AUTOMATIC TYPE

The Tsurumi automatic type pump has an integral control circuit and two float switches operated at a low voltage. The pump has an auto-cut, self resetting Circle Thermal Protector (CTP) integrated into the motor to protect the motor from overload or overheating.

This type can be identified by the suffix "A". Refer to the specification table for availability and model numbers.



AUTO-ALTERNATION TYPE

In addition to standard automatic pumps, Tsurumi offers auto-alternation type pumps. Automatic alternation operation is achieved by combining a parent pump (three floats) with a standard automatic pump (two floats). This enables each pump to operate alternately without the aid of a control panel.

How the Auto-alternation Type Works

● Operation is enabled by merely connecting the power supply.

Primary Operation

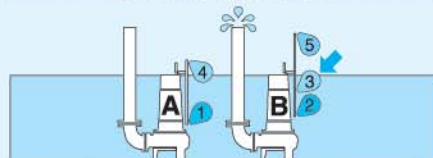

1 Float 3 operates, and pump B starts to discharge water.

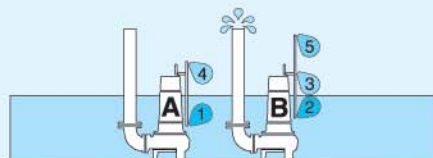

2 Water is discharged (water level falls).

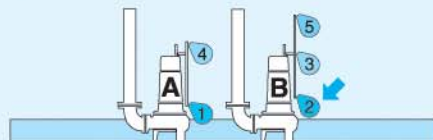

3 Stop float 2 of pump B operates to end water discharge. At this time, alternation start float 3 of pump B rests for one discharge operation.

Secondary Operation

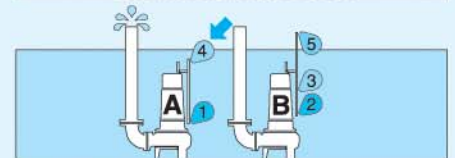

1 Start float 4 of pump A operates to start water discharge. The pump ends primary operation, and stops operating.

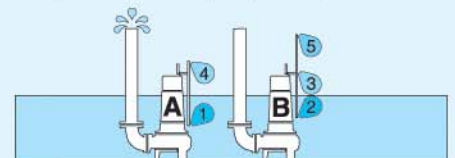

2 Water is discharged (water level falls).

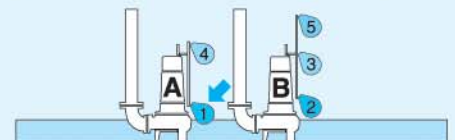

3 Stop float 1 of pump A operates to end water discharge. At the same time, start float 3 of pump B becomes ready for operation.

※ Primary operation and secondary operation are repeated alternately.

※ Both primary and secondary operations are performed simultaneously when water has risen to an abnormal level.

The parent pump can be identified by the identification "W". Auto-alternation type pumps are available in the same output range as standard automatic pumps.

U 40 · 50mm

Performance Curves

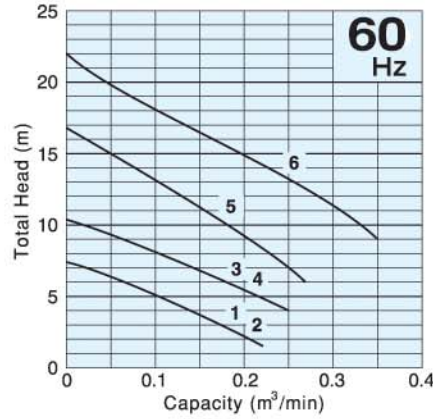
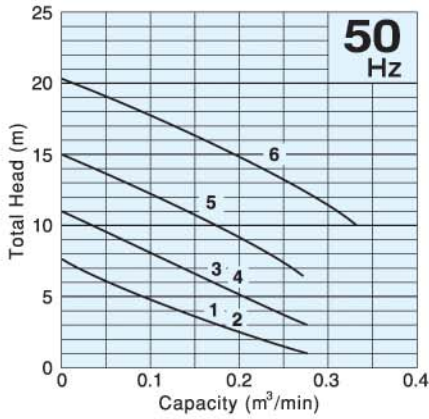

Dimensions

Free Standing

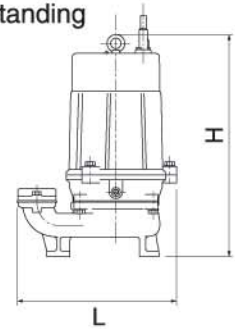

Guide Rail Fitting

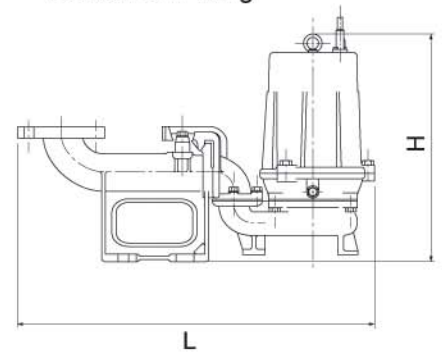

Specifications 40 · 50mm

Curve No.	Discharge Bore mm	Standard Model		Automatic Model		Auto-Alternation Model	
		Free Standing	Guide Rail Fitting	Free Standing	Guide Rail Fitting	Free Standing	Guide Rail Fitting
1	40	40U2.25S	(TOK)	40UA2.25S	(TOK)	40UW2.25S	(TOK)
2	40	40U2.25	(TOK)	40UA2.25	(TOK)	40UW2.25	(TOK)
3	50	50U2.4S	(TOK)	50UA2.4S	(TOK)	50UW2.4S	(TOK)
4	50	50U2.4	(TOK)	50UA2.4	(TOK)	50UW2.4	(TOK)
5	50	50U2.75	(TOK)	50UA2.75	(TOK)	50UW2.75	(TOK)
6	50	50U21.5	TOS50U21.5	50UA21.5	TOS50UA21.5	50UW21.5	TOS50UW21.5

Specifications 80mm

Curve No.	Discharge Bore mm	Standard Model		Automatic Model		Auto-Alternation Model	
		Free Standing	Guide Rail Fitting	Free Standing	Guide Rail Fitting	Free Standing	Guide Rail Fitting
1	80	80U2.75	TOS80U2.75	80UA2.75	TOS80UA2.75	80UW2.75	TOS80UW2.75
2	80	80U21.5	TOS80U21.5	80UA21.5	TOS80UA21.5	80UW21.5	TOS80UW21.5
3	80	80U22.2	TOS80U22.2	80UA22.2	TOS80UA22.2	80UW22.2	TOS80UW22.2
4	80	80U23.7	TOS80U23.7	80UA23.7	TOS80UA23.7	80UW23.7	TOS80UW23.7

Performance Curves

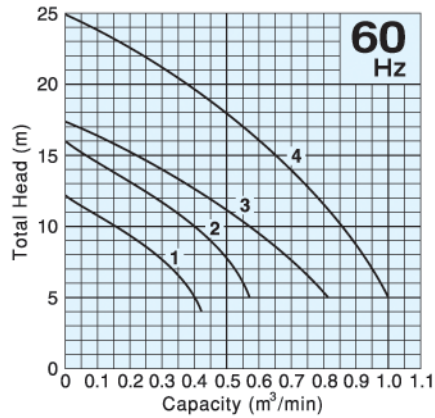
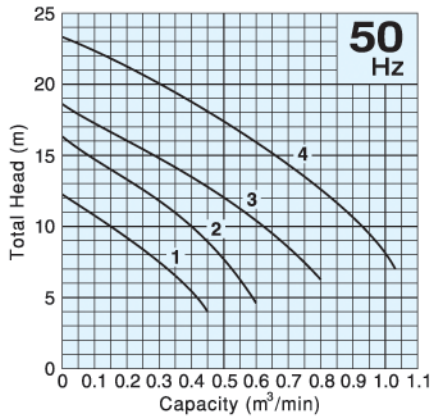

Dimensions

Free Standing

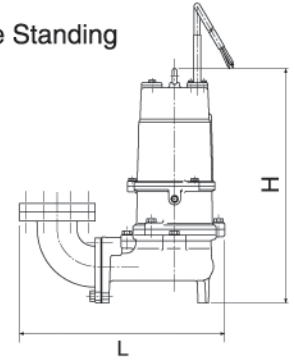

Guide Rail Fitting

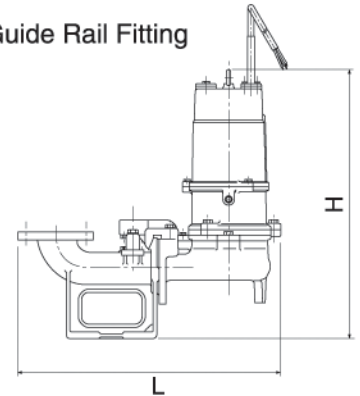

Motor Output kW	Phase	Revolution 50Hz/60Hz min ⁻¹	Starting Method	Impeller Passage mm	Standard Cable Length m	Cable Code	Dimensions L×H mm				Dry Weight kgs			
							Standard Model		Auto&Auto-Alternation Model		Standard Model		Auto&Auto-Alternation Model	
							Free Standing	Guide Rail Fitting	Free Standing	Guide Rail Fitting	Free Standing	Guide Rail Fitting ※	Free Standing	Guide Rail Fitting ※
0.25	Single	3000/3600	Split-phase	35	5	a	241×383	—	241×433	—	14.0	—	14.5	—
0.25	Three	3000/3600	D.O.L.	35	6	A	241×383	—	241×433	—	13.5	—	14.5	—
0.4	Single	3000/3600	Capacitor	35	5	a	236×433	—	236×450	—	20.0	—	20.5	—
0.4	Three	3000/3600	D.O.L.	35	6	A	236×400	—	236×450	—	19.2	—	19.7	—
0.75	Three	3000/3600	D.O.L.	35	6	A	249×393	—	266×473	—	22.7	—	23.5	—
1.5	Three	3000/3600	D.O.L.	35	6	A	297×413	658×425	334×505	696×510	31.4	36.4	32.2	27.2

※Weights without duckfoot bend.

Motor Output kW	Phase	Revolution 50Hz/60Hz min ⁻¹	Starting Method	Impeller Passage mm	Standard Cable Length m	Cable Code	Dimensions L×H mm				Dry Weight kgs			
							Standard Model		Auto&Auto-Alternation Model		Standard Model		Auto&Auto-Alternation Model	
							Free Standing	Guide Rail Fitting	Free Standing	Guide Rail Fitting	Free Standing	Guide Rail Fitting ※	Free Standing	Guide Rail Fitting ※
0.75	Three	3000/3600	D.O.L.	46	6	A	383×419	570×521	449×499	570×601	28.5	24.3	29.3	25.1
1.5	Three	3000/3600	D.O.L.	46	6	A	420×446	607×548	457×537	607×639	41.5	37.5	42.3	38.3
2.2	Three	3000/3600	D.O.L.	56	8	C	502×544	641×629	502×729	641×814	56.0	52.0	66.0	62.0
3.7	Three	3000/3600	D.O.L.	56	8	C	502×544	641×629	502×729	641×814	71.0	67.0	81.0	77.0

※Weights without duckfoot bend.

UZ 50 • 80mm

■ Dimensions

Free Standing

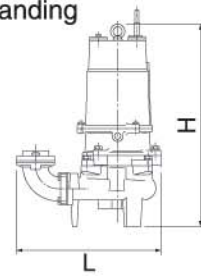

Guide Rail Fitting

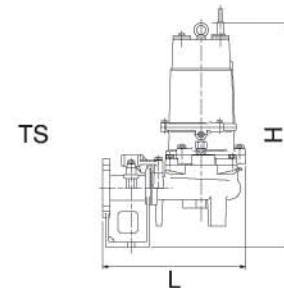
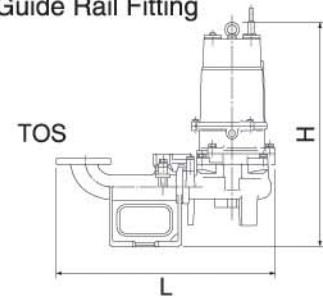

■ Performance Curves

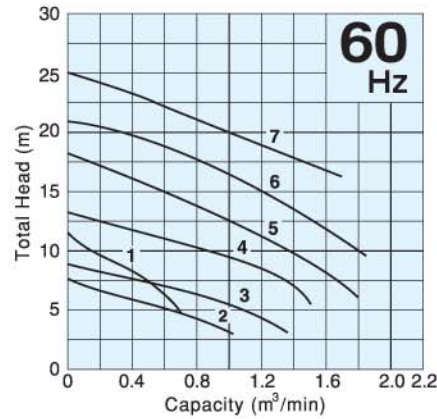
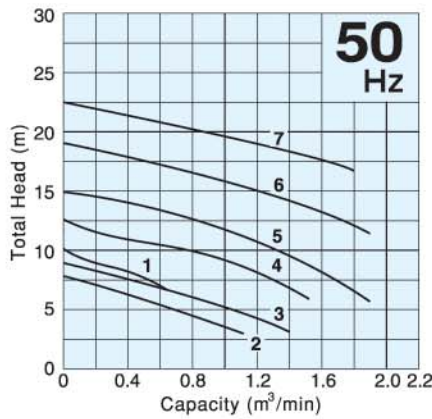

■ Specifications 50 • 80mm

Curve No.	Discharge Bore mm	Standard Model			Automatic Model			Auto-Alternation Model		
		Free Standing	Guide Rail Fitting		Free Standing	Guide Rail Fitting		Free Standing	Guide Rail Fitting	
			TOS	TS		TOS	TS		TOS	TS
1	50	50UZ41.5	TOS50UZ41.5	TS50UZ41.5	50ZA41.5	TOS50ZA41.5	TS50ZA41.5	50ZW41.5	TOS50ZW41.5	TS50ZW41.5
2	80	80UZ41.5	TOS80UZ41.5	TS80UZ41.5	80ZA41.5	TOS80ZA41.5	TS80ZA41.5	80ZW41.5	TOS80ZW41.5	TS80ZW41.5
3	80	80UZ42.2	TOS80UZ42.2	TS80UZ42.2	80ZA42.2	TOS80ZA42.2	TS80ZA42.2	80ZW42.2	TOS80ZW42.2	TS80ZW42.2
4	80	80UZ43.7	TOS80UZ43.7	TS80UZ43.7	80ZA43.7	TOS80ZA43.7	TS80ZA43.7	80ZW43.7	TOS80ZW43.7	TS80ZW43.7
5	80	80UZ45.5	TOS80UZ45.5	TS80UZ45.5	—	—	—	—	—	—
6	80	80UZ47.5	TOS80UZ47.5	TS80UZ47.5	—	—	—	—	—	—
7	80	80UZ411	TOS80UZ411	TS80UZ411	—	—	—	—	—	—

■ Specifications 100mm

Curve No.	Discharge Bore mm	Standard Model			Automatic Model			Auto-Alternation Model		
		Free Standing	Guide Rail Fitting		Free Standing	Guide Rail Fitting		Free Standing	Guide Rail Fitting	
			TOS	TS		TOS	TS		TOS	TS
1	100	100UZ43.7	TOS100UZ43.7	TS100UZ43.7	100ZA43.7	TOS100ZA43.7	TS100ZA43.7	100ZW43.7	TOS100ZW43.7	TS100ZW43.7
2	100	100UZ45.5	TOS100UZ45.5	TS100UZ45.5	—	—	—	—	—	—
3	100	100UZ47.5	TOS100UZ47.5	TS100UZ47.5	—	—	—	—	—	—
4	100	100UZ411	TOS100UZ411	TS100UZ411	—	—	—	—	—	—

■ Performance Curves

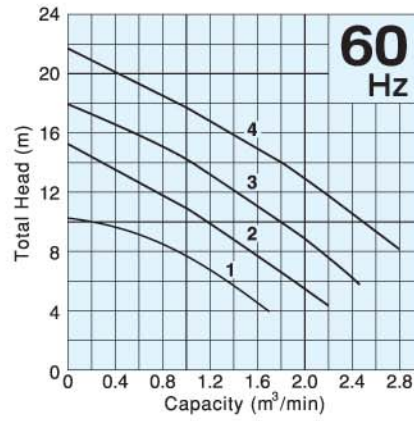
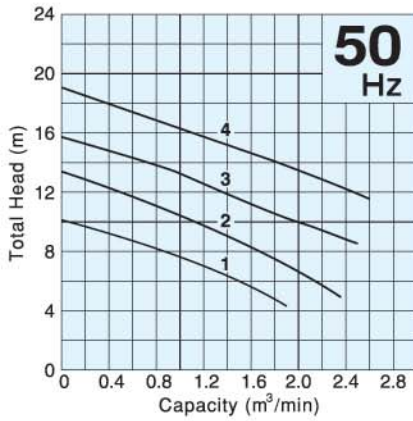

Free Standing

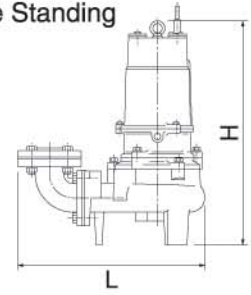

Guide Rail Fitting

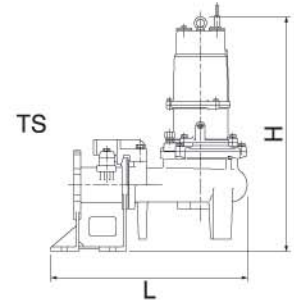
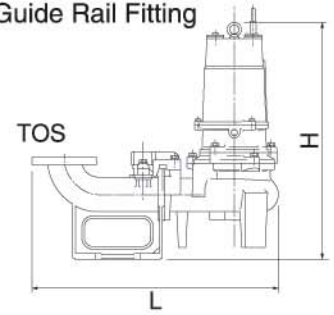

Motor Output kW	Phase	Revolution 50Hz/60Hz min ⁻¹	Starting Method	Impeller Passage mm	Standard Cable Length m	Cable Code	Dimensions L×H mm						Dry Weight kgs			
							Standard Model			Auto & Auto-Alternation Model			Standard Model		Auto & Auto-Alternation Model	
							Free Standing	Guide Rail Fitting		Free Standing	Guide Rail Fitting		Free Standing	Guide Rail Fitting ※	Free Standing	Guide Rail Fitting ※
								TOS	TS		TOS	TS				
1.5	Three	1500/1800	D.O.L.	50	6	A	405×566	621×626	398×626	405×683	621×743	435×743	52.0	50.0	58.0	56.0
1.5	Three	1500/1800	D.O.L.	80	6	A	531×637	704×670	552×670	531×754	704×787	585×787	66.0	56.0	73.0	63.0
2.2	Three	1500/1800	D.O.L.	80	6	C	531×637	704×670	552×670	531×754	704×787	585×787	66.0	57.0	73.0	64.0
3.7	Three	1500/1800	D.O.L.	80	6	C	557×688	731×721	578×721	557×861	731×894	585×894	72.0	63.0	79.0	70.0
5.5	Three	1500/1800	D.O.L.	80	8	H	595×899	768×927	615×927	—	—	—	131.0	126.5	—	—
7.5	Three	1500/1800	D.O.L.	80	8	I	595×920	768×948	615×948	—	—	—	138.0	133.5	—	—
11	Three	1500/1800	Star-Delta	80	8	L	602×981	776×1107	623×1007	—	—	—	171.5	167.0	—	—

※Weights without duckfoot bend.

Motor Output kW	Phase	Revolution 50Hz/60Hz min ⁻¹	Starting Method	Impeller Passage mm	Standard Cable Length m	Cable Code	Dimensions L×H mm						Dry Weight kgs			
							Standard Model			Auto & Auto-Alternation Model			Standard Model		Auto & Auto-Alternation Model	
							Free Standing	Guide Rail Fitting		Free Standing	Guide Rail Fitting		Free Standing	Guide Rail Fitting ※	Free Standing	Guide Rail Fitting ※
								TOS	TS		TOS	TS				
3.7	Three	1500/1800	D.O.L.	100	6	C	628×737	846×777	651×777	628×910	846×950	656×950	79.0	70.0	86.0	77.0
5.5	Three	1500/1800	D.O.L.	100	8	H	652×939	871×974	676×974	—	—	—	147.0	136.0	—	—
7.5	Three	1500/1800	D.O.L.	100	8	I	652×960	871×955	676×995	—	—	—	154.5	143.5	—	—
11	Three	1500/1800	Star-Delta	100	8	L	660×1021	879×1054	684×1054	—	—	—	184.5	173.5	—	—

※Weights without duckfoot bend.

CABTYRE CABLE CODE REFERENCE

Single-Phase

Code	Pieces per Unit	Cores × mm ²	Dia. mm	Material
a	1	3 × 1.25	10.1	PVC Sheath

*The three phase cables designated here are for 380 to 575 volts use. A thicker cable may be supplied on a certain 220 volts models.

Three-Phase

Code	Pieces per Unit	Cores × mm ²	Dia. mm	Material
A	1	4 × 1.25	11.1	PVC Sheath
C	1	4 × 2	11.8	
H	1	4 × 3.5	14.1	Chloroprene Sheath
I	1	4 × 5.5	16.8	
L	3	4 × 3.5	14.1	
		3 × 3.5	12.9	
		2 × 2	10.6	

TSURUMI OPTION

■ SPECIAL VERSION WITH GALVANIC CORRSION PROTECTION

In sea water, the effect of galvanic corrosion is more serious than that of ordinary corrosion. When two kinds of metals are dipped into an electrolytic liquid, a battery phenomenon occurs due to the difference in the electric potential of the two metals. In this case, the metal having the higher potential corrodes first. As an option, Tsurumi can supply pumps with parts made of higher electric potential metal as the sacrificial anode.

■ SPECIAL VERSION FOR HIGHER TEMPERATURE LIQUID

Standard pumps are designed for continuous running at the maximum ambient temperature of 40 C. In addition to these, Tsurumi can provide pumps for operation at higher liquid temperatures upon request. Refitting for operation at higher temperatures involves modification of not only the insulation of motor windings but also several components.

Two high-temperature operating models are available - the Rank 60 for operation in liquids up to 60 C and the Rank 90 for operation in liquids up to 90 C. Consult your dealer for more details. (These special versions are not available for some pump models.)

■ DRY PIT VERSION

The advantage of dry pit type pump is that it will not be damaged by a flooding of water, as it is constructed by a submersible pump. Tsurumi can provide dry pit type pumps as option for larger pumps in the UZ range pumps. Durable motor with effective water cooling jacket assures the pump continuous running without overheating.

■ SPECIAL VERSION WITH NON-STANDARD MATERIALS

Tsurumi can also provide you with pumps with essential components such as the impeller, pump casing, and the suction cover made of non-standard materials. Select from stainless-steel, chromium iron and bronze to suit your specific requirements. Consult your dealer for more details.

SPECIAL ACCESSORIES

■ FLOAT SWITCHES

Tsurumi offers two types of float switches (liquid level sensors). A micro-switch is incorporated in both types.

Model MC-2 is a heavy-duty type float switch with a shock absorber. Having equipped with a high grade micro switch, the MC-2 assures trouble-free operation in the liquid containing much suspended solids and floating scum. Either of the two contacts, normally-open or normally-close, can be selected as required.



Model RF-5 is an economy type float which can detect upper/lower-limit water levels with single float. The snap on-off action ensures stable operation in clean or waste water containing suspended solids or oil and fat.



We reserve the right to change the specifications and designs for improvement without prior notice.